

# Operating Instructions

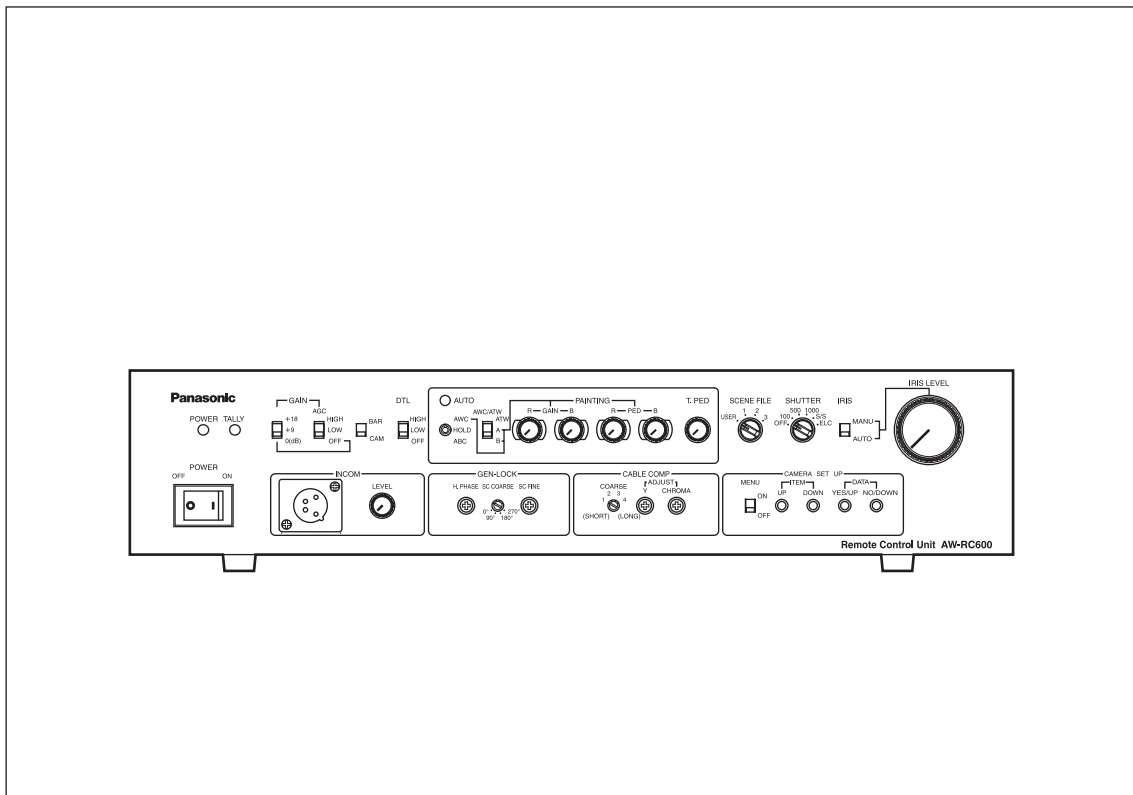

## Remote Control Unit AW-RC600P



# Panasonic®

Before attempting to connect, operate or adjust this product,  
please read these instructions completely.

# Safety precautions

	<b>CAUTION</b> RISK OF ELECTRIC SHOCK DO NOT OPEN	
CAUTION: TO REDUCE THE RISK OF ELECTRIC SHOCK, DO NOT REMOVE COVER (OR BACK). NO USER SERVICEABLE PARTS INSIDE. REFER TO SERVICING TO QUALIFIED SERVICE PERSONNEL.		



The lightning flash with arrowhead symbol, within an equilateral triangle, is intended to alert the user to the presence of uninsulated "dangerous voltage" within the product's enclosure that may be of sufficient magnitude to constitute a risk of electric shock to persons.



The exclamation point within an equilateral triangle is intended to alert the user to the presence of important operating and maintenance (service) instructions in the literature accompanying the appliance.

For CANADA

**This class A digital apparatus complies with Canadian ICES-003.**  
**Cet appareil numérique de la classe A est conforme à la norme NMB-003 du Canada.**

## WARNING:

- TO REDUCE THE RISK OF FIRE OR ELECTRIC SHOCK, DO NOT EXPOSE THIS APPARATUS TO RAIN OR MOISTURE.
- THE APPARATUS SHALL NOT BE EXPOSED TO DRIPPING OR SPLASHING AND THAT NO OBJECTS FILLED WITH LIQUIDS, SUCH AS VASES, SHALL BE PLACED ON THE APPARATUS.

## FCC Note:

This equipment has been tested and found to comply with the limits for a class A digital device, pursuant to Part 15 of the FCC Rules. These limits are designed to provide reasonable protection against harmful interference when the equipment is operated in a commercial environment. This equipment generates, uses, and can radiate radio frequency energy, and if not installed and used in accordance with the instruction manual, may cause harmful interference to radio communications. Operation of this equipment in a residential area is likely to cause harmful interference in which case the user will be required to correct the interference at his own expense.

## Warning:

To assure continued FCC emission limit compliance, the user must use only shielded interface cables when connecting to external units. Also, any unauthorized changes or modifications to this equipment could void the user's authority to operate it.

## CAUTION:

**TO REDUCE THE RISK OF FIRE OR SHOCK HAZARD AND ANNOYING INTERFERENCE, USE THE RECOMMENDED ACCESSORIES ONLY.**

## CAUTION:

In order to maintain adequate ventilation, do not install or place this unit in a bookcase, built-in cabinet or any other confined space. To prevent risk of electric shock or fire hazard due to overheating, ensure that curtains and any other materials do not obstruct the ventilation.

 indicates safety information.

# Safety precautions

## IMPORTANT SAFETY INSTRUCTIONS

Read these operating instructions carefully before using the unit. Follow the safety instructions on the unit and the applicable safety instructions listed below. Keep these operating instructions handy for future reference.

- 1) Read these instructions.
- 2) Keep these instructions.
- 3) Heed all warnings.
- 4) Follow all instructions.
- 5) Do not use this apparatus near water.
- 6) Clean only with dry cloth.
- 7) Do not block any ventilation openings. Install in accordance with the manufacturer's instructions.
- 8) Do not install near any heat sources such as radiators, heat registers, stoves, or other apparatus (including amplifiers) that produce heat.
- 9) Do not defeat the safety purpose of the polarized or grounding-type plug. A polarized plug has two blades with one wider than the other. A grounding-type plug has two blades and a third grounding prong. The wide blade or the third prong are provided for your safety. If the provided plug does not fit into your outlet, consult an electrician for replacement of the obsolete outlet.
- 10) Protect the power cord from being walked on or pinched particularly at plugs, convenience receptacles, and the point where they exit from the apparatus.
- 11) Only use attachments/accessories specified by the manufacturer.
- 12) Use only with the cart, stand, tripod, bracket, or table specified by the manufacturer, or sold with the apparatus. When a cart is used, use caution when moving the cart/apparatus combination to avoid injury from tip-over. 
- 13) Unplug this apparatus during lightning storms or when unused for long periods of time.
- 14) Refer all servicing to qualified service personnel. Servicing is required when the apparatus has been damaged in any way, such as power-supply cord or plug is damaged, liquid has been spilled or objects have fallen into the apparatus, the apparatus has been exposed to rain or moisture, does not operate normally, or has been dropped.

 indicates safety information.

# Contents

---

<b>Introduction</b> .....	<b>4</b>	<b>Adjustment</b> .....	<b>15</b>
<b>Accessories</b> .....	<b>4</b>	Cable compensation .....	15
<b>Precautions for use</b> .....	<b>5</b>	White balance adjustments .....	16
<b>Parts and their functions</b> .....	<b>6</b>	Black balance adjustments .....	17
Front panel .....	6	Gen-lock adjustment .....	18
Rear panel .....	11	<b>Menu item setting</b> .....	<b>19</b>
<b>Connections</b> .....	<b>13</b>	<b>Rack mounting</b> .....	<b>20</b>
<b>Operating procedure</b> .....	<b>14</b>	<b>Appearance</b> .....	<b>21</b>
		<b>Specifications</b> .....	<b>22</b>

## Introduction

---

This remote control unit (RCU) is designed to be used with a convertible camera (such as the AW-E860, AW-E750, AW-E650, AW-E655 or AW-E350).

By connecting the RCU cable (AW-CA50A26), the power supply to the camera as well as the camera settings, switching operations and adjustments can be performed by remote control.

The unit comes with a tally/intercom input/output connector, AUX input/output connector (for line viewing) and G/L input/output connector to make it easy to configure a system.

Also provided are controller connectors for controlling a contact-type pan/tilt head and lens.

The maximum extendible length of the cables is as follows:

- Camera body (including lens): 984 ft. (300 m)
- AW-E860 + AW-PB305 (studio card) + 5-inch viewfinder: 328 ft. (100 m)

• Cables		
AW-CA50A26	RCU cable	49.2 ft. (15 m)
WV-CA26U15	Studio cable for extension	49.2 ft. (15 m)
WV-CA26U30	Studio cable for extension	98.4 ft. (30 m)
WV-CA26U100	Studio cable for extension	328 ft. (100 m)
WV-CA26T26	Joint connector for extension	

### Note

When the remote control unit is to be discarded at the end of its service life, ask a specialized contractor to dispose of it properly in order to protect the environment.

## Accessories

---

<b>Power cable</b> .....	<b>1</b>	<b>Rack angle handles</b> .....	<b>2</b>
<b>Rack-mount angles</b> .....	<b>2</b>	<b>Rack angle handle fixing screws</b> .....	<b>4</b>
<b>Mounting screws</b> .....	<b>4</b>		

# Precautions for use

---

- **Handle the unit carefully.**

Dropping the unit or subjecting it to strong impact may give rise to malfunctioning or accidents.

- **Operate the unit within a temperature range of 14°F (–10°C) to 113°F (+45°C).**

Operation in locations below 14°F (–10°C) or above 113°F (+45°C) may adversely affect the internal parts.

- **Turn off the power before connecting or disconnecting the cables.**

Be absolutely sure to turn off the power before connecting or disconnecting the cables.

- **AC 120 V is the unit's rated supply voltage.**

Be absolutely sure to supply an AC 120 V voltage to the unit.

- **Maintenance**

Wipe the unit using a dry cloth. To remove stubborn dirt, dip a cloth into a diluted solution of kitchen detergent, wring it out well, and wipe the unit gently.

**Caution**

- Avoid using benzine, paint thinners and other volatile fluids.
- If a chemical cleaning cloth is to be used, carefully read through the precautions for its use.

# Parts and their functions

## ■ Front panel

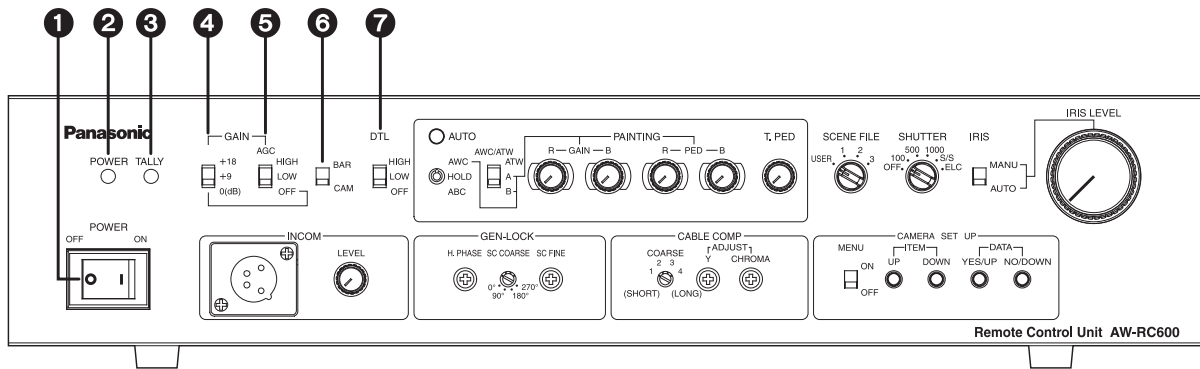

### 1 Power switch [POWER OFF/ON]

- ON:** At this setting, the power is supplied to the unit (and the power indicator LED lights).  
**OFF:** At this setting, the power is off.

### 2 Power indicator LED [POWER]

When the power switch is set to [ON], this LED lights up green to indicate that the unit can be operated.

### 3 Tally indicator LED [TALLY]

Connect the unit's tally/intercom input/output connector (3) with the TALLY & INCOM connector on the live switcher (AW-SW350). This LED lights up red when the unit is selected using the controls on the live switcher.

### 4 Gain increase selector switch [GAIN +18/+9/0(dB)]

This switch is operational only when the AGC selector switch 5 is at the [OFF] setting.

When the AGC selector switch 5 is at the [LOW] or [HIGH] setting, the gain will remain unchanged even when the setting of the gain increase selector switch is switched.

The switch is normally used as the [0 dB] position. When shooting in dark locations and a sufficient video output cannot be obtained even by setting the lens iris to wide open, set it to [+9 dB] or [+18 dB].

### 5 AGC selector switch [AGC HIGH/LOW/OFF]

**HIGH:** At this setting, the maximum AGC gain is set to +30 dB. (This value may differ according to the camera used.)

**LOW:** At this setting, the maximum AGC gain is set to +18 dB. (This value may differ according to the camera used.)

**OFF:** AGC does not function. Select the gain using the gain increase selector switch 4.

### Fine adjustment of AGC

If, when this switch is at the [HIGH] or [LOW] setting, the scene file switch 14 is set to [USER], [Auto iris adjust] is set to [ON] on the camera menu and the lens iris selector switch 16 is set to [AUTO], the AGC level can be finely adjusted using the lens iris control 17.

(For details on the camera menus, refer to the camera's operating instructions.)

### 6 Color bar/camera selector switch [BAR/CAM]

Set this switch to [BAR] to output color bar signals. Normally, it is used as the [CAM] setting.

### 7 Detail compensation selector switch [DTL HIGH/LOW/OFF]

This switch is used to set the amount of detail compensation to HIGH, LOW or OFF. Select the preferred setting.

# Parts and their functions

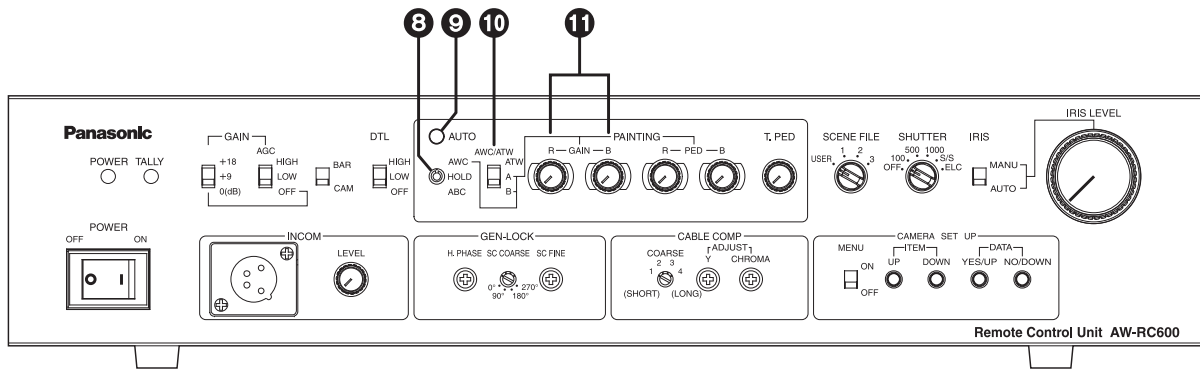

## 8 Auto white/auto black setting switch

### [AWC/HOLD/ABC]

Automatic adjustment of the white balance starts when this switch is set to the top position while the white balance selector switch 10 is at the [A] or [B] position. Regardless of the white balance selector switch 10 setting, when the switch is set to the bottom position, the lens iris closes and the automatic adjustment of the black balance starts.

The switch's mechanism is designed to return the switch to the [HOLD] setting when the switch is released, but the automatic adjustment continues until it is completed.

### Caution

The black balance cannot be adjusted properly unless the lens iris is completely closed.

Automatic adjustment of the white balance and black balance is not performed when [BAR] has been selected as the color bar/camera selector switch 6 or when the camera's menu is displayed due to the setting of the menu ON/OFF switch 25.

## 9 Auto setting indicator LED [AUTO]

This LED starts blinking when the automatic adjustment of the white balance or black balance is started by the auto white/auto black setting switch 8; it stops blinking and goes off when the adjustment ends successfully. If this LED is lighted, it means that the adjustment has not ended successfully.

If the white balance has not ended successfully, change the lens iris setting, lighting, subject or other aspects, and try performing the automatic adjustment again.

If the black balance has not ended successfully, close the lens iris completely, and try performing the automatic adjustment again.

## 10 White balance selector switch

### [AWC/ATW ATW/A/B]

This switch is used to select the auto white balance setting.

**ATW:** At this setting, the camera provides compensation in such a way that the white balance is adjusted automatically even when the light source or color temperature has changed. The result is images in which nothing feels odd or out of place.

### Notes:

- This function may not operate properly if a source of high brightness (such as a fluorescent light) is shown on the screen.
- The white balance may shift if there are no white objects on the screen.

**A or B:** When the white balance is being automatically adjusted by the auto white/auto black setting switch 8, the color temperature conditions can be stored in memory [A] or [B].

## 11 Red and blue gain adjustment controls

### [PAINTING GAIN R/B]

These controls enable the white balance to be adjusted finely when the white balance selector switch 10 is at the [A] or [B] setting.

When the white balance is automatically adjusted again after it has been finely adjusted, it will return to the status prior to the fine adjustment regardless of the positions of these controls.

The function of the controls may be implemented in steps since the processing involved uses digital signals: This is normal and does not indicate any malfunctioning.

# Parts and their functions

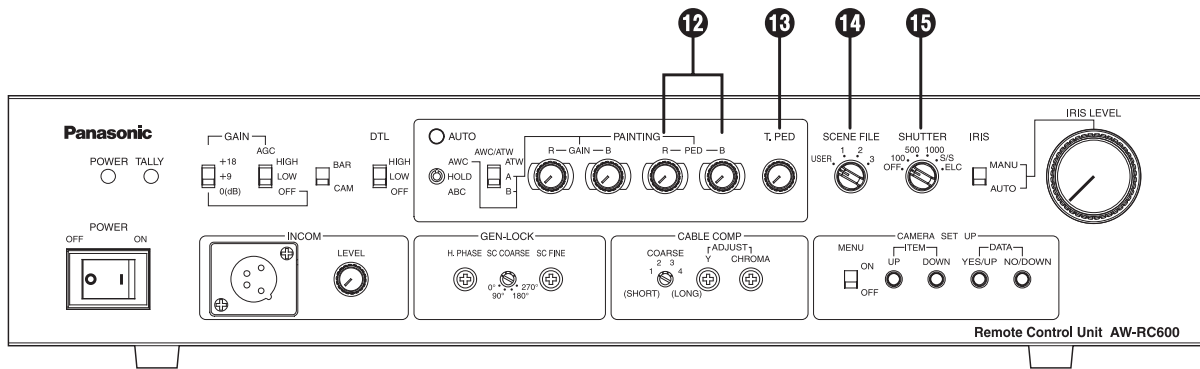

## 12 Red and blue pedestal adjustment controls [PAINTING PED R/B]

These controls enable the black balance to be adjusted finely.

When the black balance is automatically adjusted again after it has been finely adjusted, it will return to the status prior to the fine adjustment regardless of the positions of these controls.

The function of the adjustment controls may be implemented in steps since the processing involved uses digital signals: This is normal and does not indicate any malfunctioning.

## 13 Total pedestal adjustment control [T.PED]

This control enables the pedestal level of the video signals to be adjusted. It is used when, for instance, the pedestal level of two or more cameras is to be adjusted.

The function of the control may be implemented in steps since the processing involved uses digital signals: This is normal and does not indicate any malfunctioning.

## 14 Scene file switch [USER/1/2/3]

This switch is used to select the camera's scene files.

**USER:** USER mode

- 1: Halogen light mode
- 2: Fluorescent light mode
- 3: Outdoor mode

Select the scene file which is optimally suited to the shooting conditions.

(For details, refer to the camera's operating instructions.)

## 15 Electronic shutter selector switch [SHUTTER OFF/100/500/1000/ S/S /ELC]

This switch enables the shutter speed (OFF, 1/100, 1/500, 1/1000) as well as S/S and ELC to be selected.

**S/S:** This stands for synchro scan. The shutter speed can be varied continuously at this setting. (60.34 Hz to 15.75 kHz)

Display the camera's menu using the menu ON/OFF switch 16, and set the shutter speed. (For details, refer to the camera's operating instructions.)

**ELC:** At this setting, the electronic shutter is controlled, and the light quantity is automatically adjusted.

### Fine adjustment of ELC

ELC can be finely adjusted using the lens iris control 17 by setting the scene file switch 14 to [USER], setting [Auto iris adjust] to [ON] using the camera's menu and setting the lens iris selector switch 16 to [AUTO] when this switch is at [ELC].

(For details of the camera menus, refer to the camera's operating instructions.)

### Note:

Smear may appear with high-brightness subjects when the electronic shutter selector switch is set to ELC.



# Parts and their functions

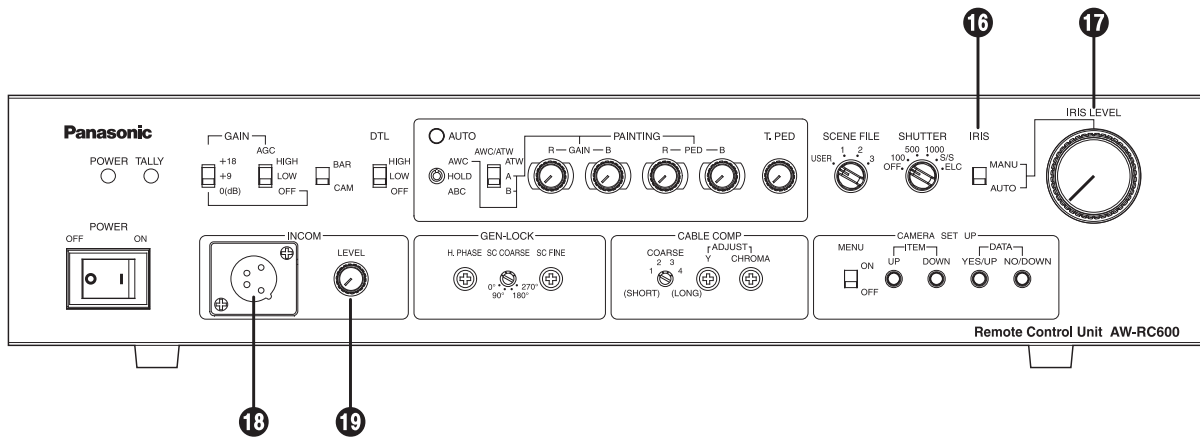

## 16 Lens iris selector switch [IRIS MANU/AUTO]

The lens is set to automatic iris (ALC) if this switch is set to [AUTO] when the iris selector switch on the lens is at [AUTO]. The lens iris can now be finely adjusted using the lens iris control 17 by setting the scene file switch 14 to [USER] and setting [Auto iris adjust] to [ON] using the camera's menu in this status.

(For details of the camera menus, refer to the camera's operating instructions.)

When the switch is set to [MANU], the lens iris can be adjusted manually from closed to wide open using the lens iris control 17.

## 17 Lens iris control [IRIS LEVEL]

ALC (AGC and ELC) can be finely adjusted by setting the lens iris selector switch 16 to [AUTO], the scene file switch 14 to [USER], and [Auto iris adjust] to [ON] using the camera's menu.

When the lens iris selector switch 16 is set to [MANU], the lens iris can be adjusted manually from closed to wide open.

### Note:

The ALC cannot be finely adjusted and the lens iris cannot be adjusted when the iris selector switch on the lens is set to a position other than [AUTO] (such as [MANU]).

With some lenses, the open and close directions with respect to the control directions may be reversed. If this is the case, contact the lens manufacturer or your dealer.

## 18 Intercom connector [INCOM] (XLR 4-pin connector)

A headset is connected here. Intercommunication is then possible between the camera, RCU and live switcher. Set the INCOM selector switch on the live switcher (AW-SW350) to the [3-wire type].

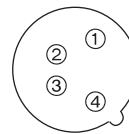

- 1: GND
- 2: MIC (this is where the headset microphone is connected)
- 3: GND
- 4: SPEAKER (this is where the headset speaker is connected)

- Use a dynamic type of microphone with an impedance of approximately 200 ohms for the headset to be connected.

Recommended headset:

HRM-201D (Ashida Sound Co., Ltd)  
CC-26K (CLEAR-COM)

## 19 Intercom volume adjustment control [INCOM LEVEL]

This is used to adjust the volume of the sound heard through the speaker of the headset connected to the INCOM connector.

# Parts and their functions

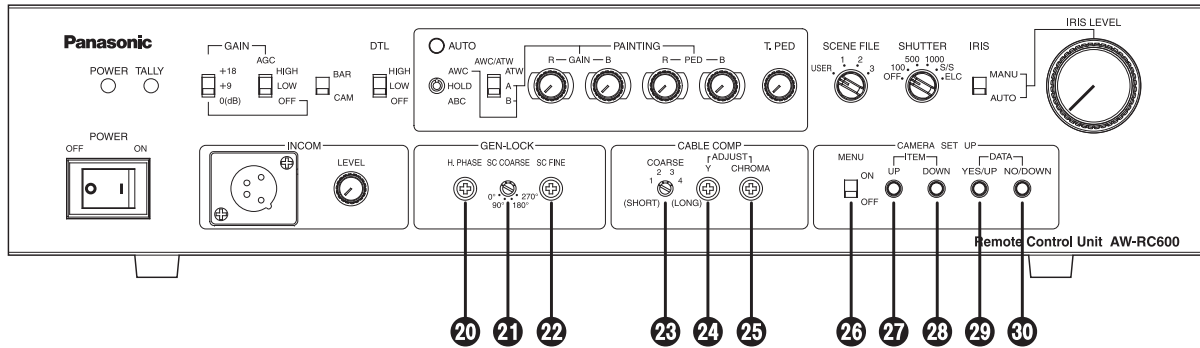

## 20 Horizontal phase adjustment control [H.PHASE]

This is used to adjust the horizontal phases of the gen-lock input and video output when two or more cameras are used at the same time.

## 21 Subcarrier phase coarse adjustment switch [SC COARSE]

This is used to adjust the hue of the gen-lock input and video output coarsely when two or more cameras are used at the same time. When used in combination with the subcarrier phase fine adjustment control 22, the adjustable range is greater than 360 degrees.

## 22 Subcarrier phase fine adjustment control [SC FINE]

This is used to adjust the hue of the gen-lock input and video output finely when two or more cameras are used at the same time. When used in combination with the subcarrier phase coarse adjustment switch 21, the adjustable range is greater than 360 degrees.

## 23 Cable compensation selector switch [COARSE]

This is set in line with the length of the cable between the camera and RCU.

Switch position	Cable length
1	Less than 246 ft. (75 m)
2	246 to 492 ft. (75 to 150 m)
3	492 to 754.4 ft. (150 to 230 m)
4	754.4 to 984 ft. (230 to 300 m)

(The cable lengths above are approximations only.)

## 24 Y gain adjustment control [ADJUST Y]

This is used to adjust the Y (luminance) level of the video output signals to match the cable length. (Select the cable length using the cable compensation selector switch 23 before adjusting the level. The chroma amount is also varied by this control.)

## 25 Chroma gain adjustment control [ADJUST CHROMA]

This is used to adjust the chrominance level of the video output signals to match the cable length. (Select the cable length using the cable compensation selector switch 23 and adjust the Y level of the video output signals using the Y gain adjustment control 24 before adjusting the level.)

## 26 Menu ON/OFF switch [MENU OFF/ON]

**OFF:** Only the camera's images are output to the video output.

**ON:** The camera's images and superimposed camera's menu are output to the video output.

- Menu items can be selected and data changed using the item UP switch 27, item DOWN switch 28, DATA YES/UP switch 29 and DATA NO/DOWN switch 30. For details on the menu items and contents, refer to the camera's operating instructions.

## 27 Item UP switch [ITEM UP]

When this is pressed while a menu is displayed, the item which is the next one up from the current item on the menu can be selected.

## 28 Item DOWN switch [ITEM DOWN]

When this is pressed while a menu is displayed, the item which is the next one down from the current item on the menu can be selected.

## 29 DATA YES/UP switch [DATA YES/UP]

When this is pressed while the main menu is displayed, the submenus of the items are displayed.

When it is pressed while a submenu is displayed, the setting is incremented.

## 30 DATA NO/DOWN switch [DATA NO/DOWN]

When this is pressed while the main menu is displayed, the item which is the next one down from the current item on the menu can be selected.

When it is pressed while a submenu is displayed, the setting is decremented.

# Parts and their functions

## ■Rear panel

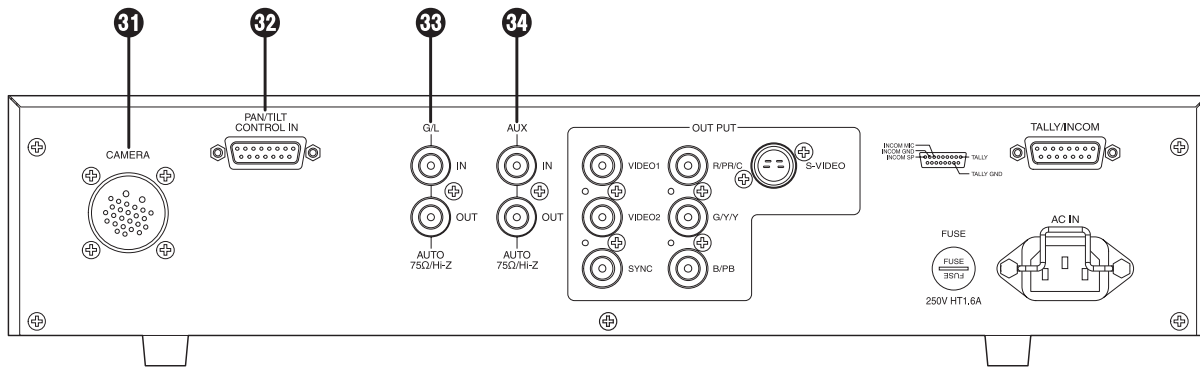

### 31 Camera cable connector [CAMERA] (26-pin connector)

The camera's cable (such as the AW-CA50A26) is connected here.

### 32 Contact-type pan/tilt head control connector [PAN/TILT CONTROL IN] (D-SUB 15-pin connector)

- This has the same shape as the tally/intercom input/output connector. Take care not to confuse the two when connecting them.
- A controller for controlling the lens (a lens with zoom and focus servo) and pan/tilt head (up, down, left, right, defroster, wiper, etc.) is connected here. (Only a contact-type controller can be connected.)

Pin No.	Signal Name
1	LEFT
2	RIGHT
3	UP
4	DOWN
5	FAR
6	NEAR
7	TELE
8	WIDE
9	DEFROSTER
10	WIPER
11	COMM
12	+5 V
13	+V (+7.5 V)
14	-V (+2.5 V)
15	GND

- The optional board must be installed in the camera in order to use a contact-type pan/tilt head. For details, refer to the camera's operating instructions.
- When the control pins (#1 to #10) are connected to the COMM pin (#11), the control signals are sent from the RCU to the camera.
- When the controller is to be fabricated, connect a resistor with a resistance of 1 to 10 kilohms (1/8 W or more) between the COMM pin and +5 V pin.

- Ensure that both the LEFT and RIGHT pins are not connected to the COMM pin at the same time.
- Similarly, do not connect both the UP and DOWN, FAR and NEAR or WIDE and TELE pins to the COMM pin at the same time.
- Pins #12 to #15 are used when exercising lens control only. To do this, connect the controller's FOCUS CONT pin to NEAR (pin #6) and its ZOOM CONT pin to WIDE (pin #8). (Normally, pins #12 to #15 are not used when exercising control by contacts.)

### 33 Gen-lock input/output connector [G/L IN/OUT] (75-ohm automatic termination)

The external sync signals (black burst signals or composite signals) from another system are connected here.

#### Note:

The input signals must be connected to the BNC connector marked "IN" (75-ohm automatic termination). If it is connected to the BNC connector marked "OUT," a high-impedance state will result, and the connector will not be terminated by the 75-ohm resistance.

### 34 AUX signal input/output connector [AUX IN/OUT] (75-ohm automatic termination)

Connect the line view signals from a live switcher or other device here.

#### Note:

The input signals must be connected to the BNC connector marked "IN" (75-ohm automatic termination). If it is connected to the BNC connector marked "OUT," a high-impedance state will result, and the connector will not be terminated by the 75-ohm resistance.

# Parts and their functions

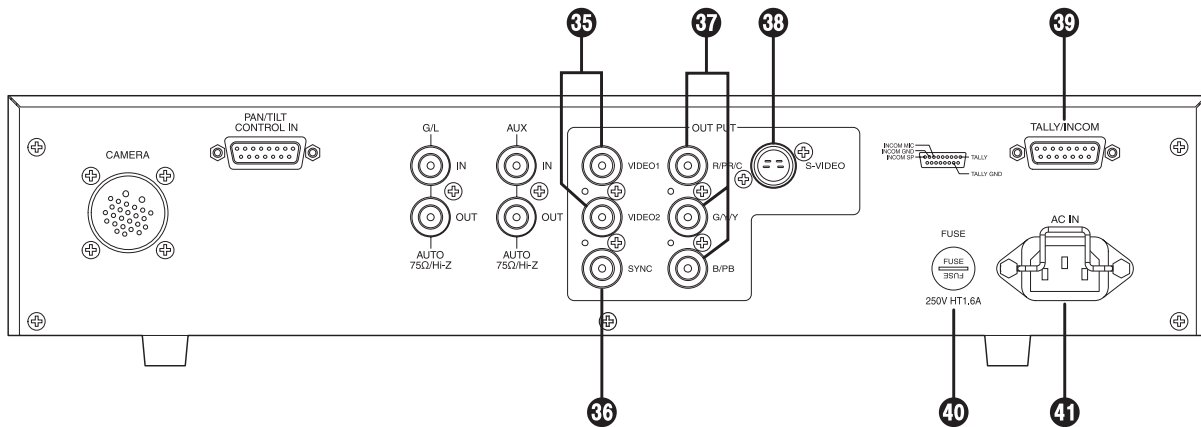

## 35 Video output connectors [VIDEO1, VIDEO2]

The video signals from the camera after cable compensation are output from these connectors. (The same signal is output from connectors 1 and 2.) Connect the connectors to the video input connectors on the live switcher, color monitor, VTR or other device. (Output impedance: 75 ohms)

## 36 SYNC output connector [SYNC]

The composite sync signal is output from this connector. Connect the connector to the gen-lock input connector on the color monitor or other device. (Output impedance: 75 ohms)

## 37 RGB/Y, PR and PB/YC output connectors [R/PR/C, G/Y/Y, B/PB]

If a camera such as the AW-E650 with RGB/Y, PR and PB/YC signal output facilities is connected to the remote control unit, its signals are output from these connectors. (Output impedance: 75 ohms)  
The RGB/Y, PR or PB/YC signals are selected using the camera's menu. (For details, refer to the camera's operating instructions.)

## 38 S-Video output connector [S-VIDEO OUT] (4-pin S-connector)

The same signals as the ones output from the R/PR/C and G/Y/Y connectors among the RGB/Y, PR and PB/YC output connectors 37 are output from this connector. (Output impedance: 75 ohms)  
The YC signals are selected using the camera's menu, and connected to a color monitor or other device equipped with an S-Video input connector.

### Note:

When the RGB/Y, PR and PB/YC output connectors 37 and S-Video output connector 38 are used at the same time, the level of the output signals will be reduced. Therefore, use either connectors 37 or connector 38 in line with the connectors used on the device connected to the remote control unit.

## 39 Tally/intercom input/output connector [TALLY/INCOM] (D-SUB 15-pin connector)

Connect this to the TALLY & INCOM connector on the live switcher (AW-SW350). Set the INCOM selector switch on the live switcher (AW-SW350) to [3-wire type]. When inputting the tally control signals from another device, input them with 0V for ON and open for OFF.

Pin No.	Signal Name
1	TALLY
6	INCOM MIC
7	INCOM GND
8	INCOM SP
11	TALLY GND

## 40 Fuse holder [FUSE]

Fuse used: HT1.6AN5 (AC 250 V, 1.6 A)

## 41 AC power socket [AC IN]

Attach one end of the power cord provided to this socket and the other end to the AC 120V (60 Hz) power supply.

# Connections

- Before proceeding with the connections, ensure that the power to all the devices is off.
- Be absolutely sure to use the AW-CA50A26 RCU cable to connect the RCU to the camera.
- When extending the cable, use the extension-use studio cable (WV-CA26U15, WV-CA26U30 or WV-CA26U100) and extension-use joint connector (WV-CA26T26).
- The maximum length to which the cable can be extended is 984 ft. (300 m) (for a camera body and lens).  
When using the studio card (AW-PB305) and attaching a viewfinder, it can be extended up to 328 ft. (100 m).
- When the power switch of the RCU is set to ON, the power indicator LED lights up, and the camera is controlled from the RCU.

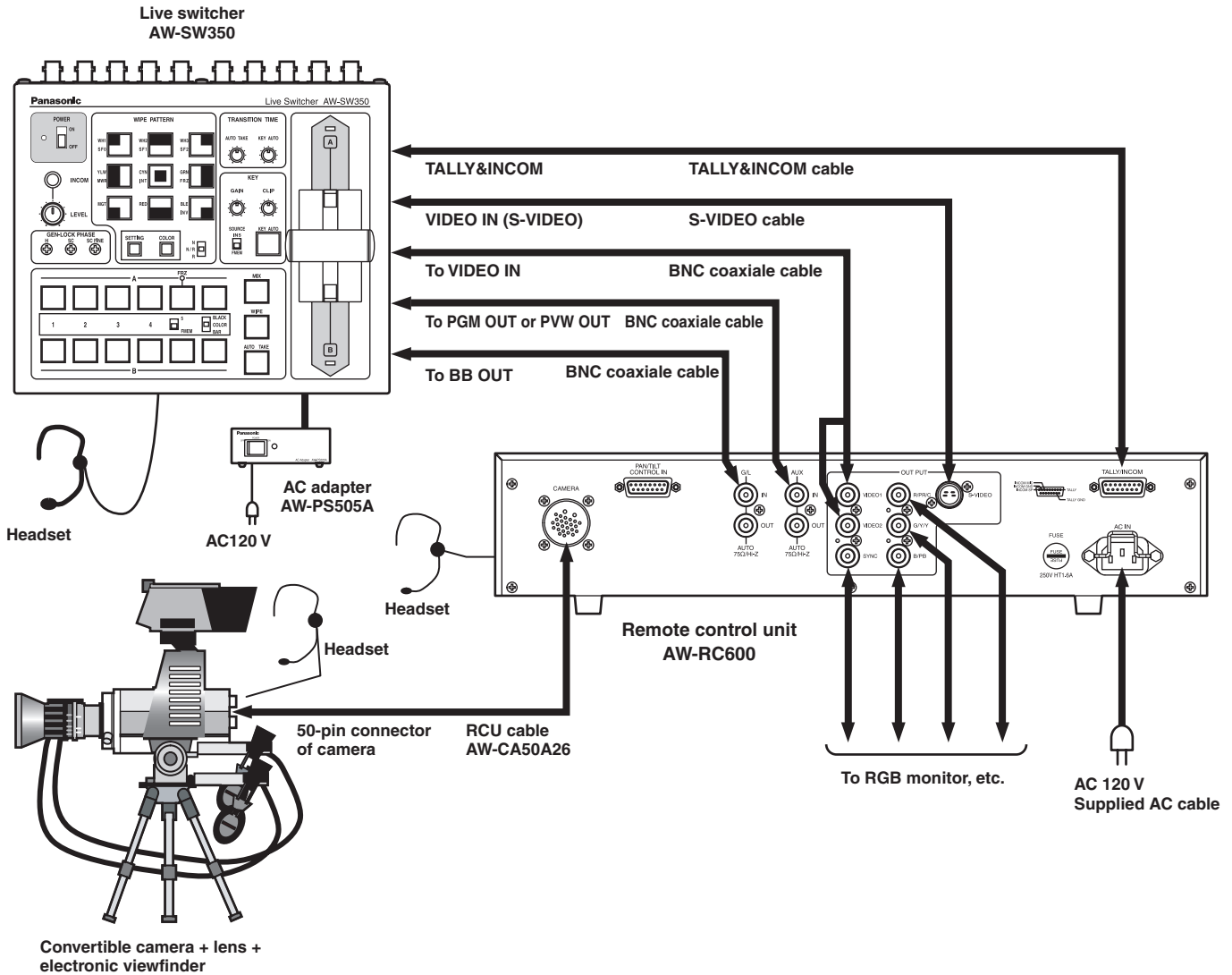

The AW-PB305 studio card and viewfinder installation bracket are required to connect an electronic viewfinder to a convertible camera.

- Notes:**
- When the R/G/B, Y/PR/PB and Y/C signals are used, select the required signals using the camera's menu.
  - When using the S-Video signals, select Y/C using the camera's menu. **Furthermore, use either the S-Video connector or BNC connectors, and leave the other connectors unconnected.**  
The S-Video connector and BNC connectors cannot be used at the same time.
  - **Connect either the VIDEO OUT BNC connector or S-Video connector to the AW-SW350 live switcher.**
  - Use an intercom headset suited to all the devices.
  - Fabricate the TALLY & INCOM cables without mixing up the signals.

# Operating procedure

## 1. Turn on the power.

Set the unit's power switch to [ON].

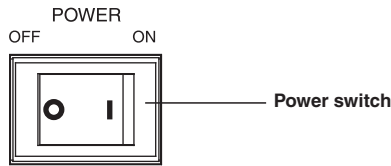

## 2. Proceed with the cable compensation and gen-lock adjustments.

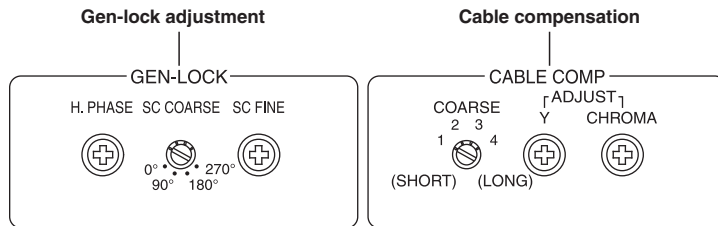

## 3. Adjust the white balance.

- This adjustment must be performed when the unit is used for the first time or when the unit has not been used for a prolonged period.
- It must also be performed when the light conditions or brightness has changed.
- Once the white balance has been adjusted, there is no need to adjust it again provided that the unit will be used under the same conditions.
- When the white balance selector switch is used at the ATW setting, the white balance need not be adjusted.

## 4. Adjust the black balance.

- This adjustment must be performed when the unit is used for the first time or when the unit has not been used for a prolonged period.
- It must also be performed when the ambient temperature has changed significantly or at the beginning of a new season.
- Once the black balance has been adjusted, there is no need to adjust it again provided that the unit is going to be used under the same conditions.

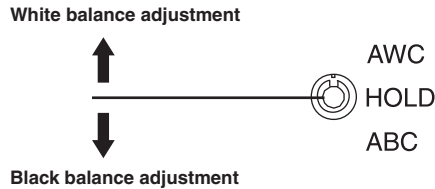

## 5. Set the switches to match the shooting conditions.

# Adjustment

## ■ Cable compensation

1. Turn the cable compensation selector switch to match the length of the cable connecting the camera and the RCU.

Switch position	Cable length
1	Less than 246 ft. (75 m)
2	246 to 492 ft. (75 to 150 m)
3	492 to 754.4 ft. (150 to 230 m)
4	754.4 to 984 ft. (230 to 300 m)

(The cable lengths above are approximations only.)

2. Connect the wave form monitor (or oscilloscope) and vectorscope to the video output connectors. (75 ohms termination)
3. Switch the camera signal to color bar and adjust the Y (luminance) level and chrominance level with the Y gain adjustment control and the chroma gain adjustment control, respectively.

If the camera output color bar is normal, adjust the values as below.

**Y Level:** 100 IRE (0.714 Vp-p)

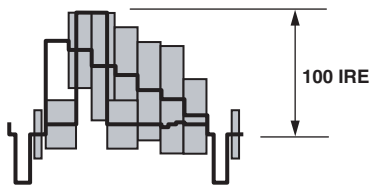

**Chrominance level:** Each color should be in the vectorscope frame.

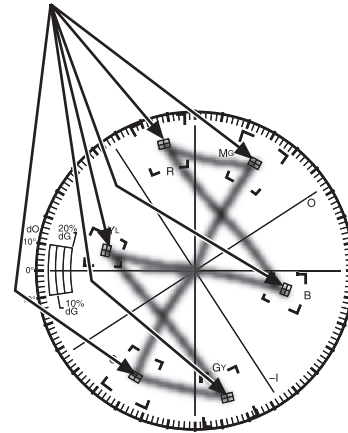

# Adjustment

## ■ White balance adjustments

### ● Automatic adjustment (AWC)

- Two sets of color temperature conditions can be stored in the memory.
- When using the unit under the same conditions as the ones stored in the memory, there is no need to re-adjust the white balance.
- When the white balance is automatically adjusted again, the data in the memory is rewritten.

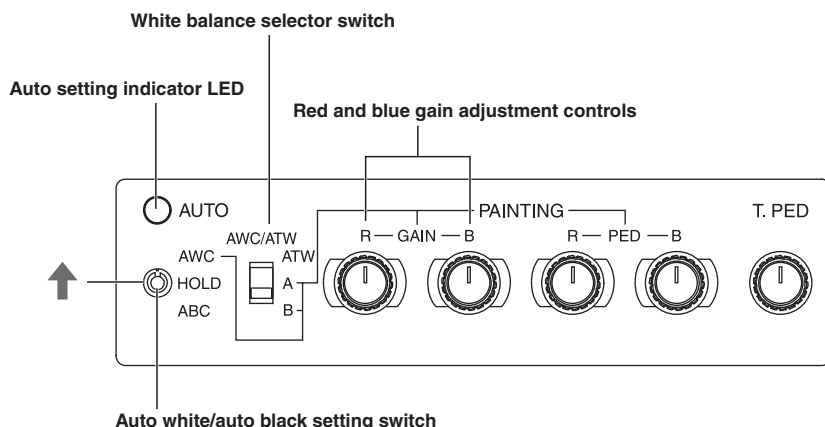

The white object must occupy over 10 % of the monitor screen area.

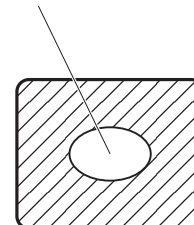

1. Set the white balance selector switch to [A] or [B].

2. Fill the screen with a white object.

The white object must have a size which is at least 10% of the screen size, and it must be displayed in the screen center. Do not allow shiny objects and very bright objects to appear on the screen.

3. The white balance can be automatically adjusted by setting the auto white/auto black setting switch to [AWC].

While the white balance is being automatically adjusted, the auto setting indicator LED starts blinking: it goes off if the adjustment is successful and lights up if it is not successful.

If the adjustment is not successful, change the lens iris setting, lighting, subject and/or other conditions, and try performing the automatic adjustment again.

4. After automatically adjusting the white balance, use the red and blue gain adjustment controls to finely adjust the white balance.

#### Note:

When the white balance is automatically adjusted again after it has been finely adjusted, it will return to the status prior to the fine adjustment regardless of the positions of the red and blue gain adjustment controls.

### ● Automatic color temperature search (ATW)

When the white balance selector switch is set to [ATW], the camera provides compensation automatically in such a way that the white balance is adjusted automatically even when the light source or color temperature has changed. The result is images in which nothing feels odd or out of place.

#### Notes:

- The white balance may shift if there are no white objects on the screen.
- With some light sources or at some color temperatures, it may not be possible to compensate the white balance completely.



# Adjustment

## ■ Black balance adjustments

### ● Automatic adjustment (ABC)

1. The black balance can be automatically adjusted by setting the auto white/auto black setting switch to [ABC].

While the black balance is being automatically adjusted, the auto setting indicator LED starts blinking: it goes off if the adjustment is successful and lights up if it is not successful. If the adjustment is not successful, try performing the automatic adjustment again.

(If the black balance is automatically adjusted with the lens iris selector switch at [AUTO], the lens iris will be closed automatically. Check that the lens iris is completely closed.)

2. After automatically adjusting the black balance, use the red and blue pedestal adjustment controls to finely adjust the black balance.

#### Note:

When the black balance is automatically adjusted again after it has been finely adjusted, it will return to the status prior to the fine adjustment regardless of the positions of the red and blue pedestal adjustment controls.

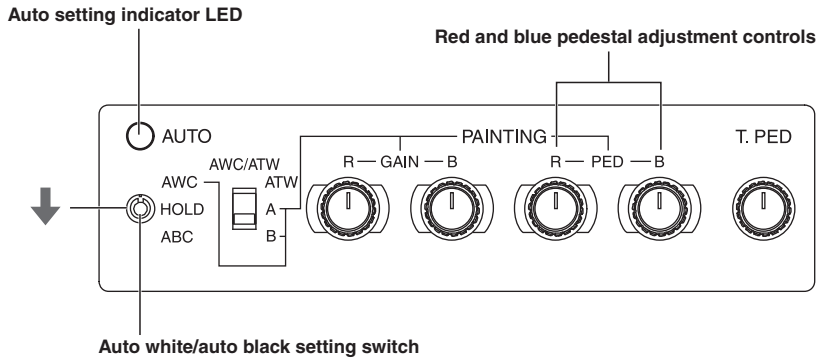

# Adjustment

## ■ Gen-lock adjustment

When using the gen-lock function, the phases of the signals must be adjusted to bring the phases into alignment with the other devices and camera.

Before proceeding with the adjustment, switch the camera's video signals to color bar signals.

### ● Horizontal phase adjustment

Using a dual-trace oscilloscope, monitor the waveforms of the gen-lock input signals (black burst signals) and video output signals, and align the horizontal phase using the horizontal phase adjustment control.

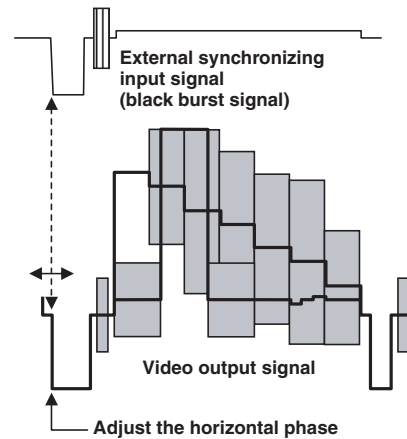
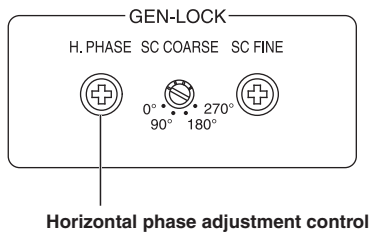

### ● Hue adjustment

1. Connect the video output signals to a vectorscope.
2. Set the vectorscope to the gen-lock mode using the same gen-lock signals.
3. Observe the waveforms on the vectorscope, and use the subcarrier phase coarse adjustment switch and the subcarrier phase fine adjustment control to set the colors of the color bars to the prescribed phase.

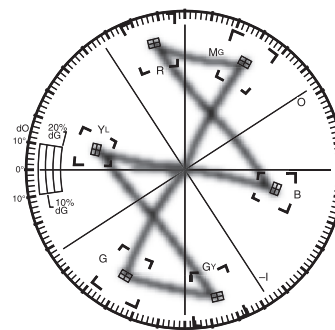
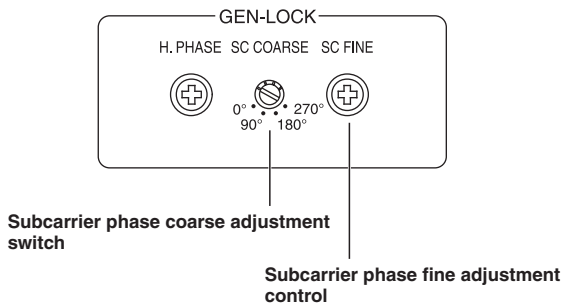

# Menu item setting

---

The settings of the convertible camera were preset when the camera was shipped from the manufacturing plant. However, the menu items can be set or changed for each mode to match the actual shooting conditions. For details, refer to the camera's operating instructions.

## • Menu displays

These displays can be set when the menu ON/OFF switch is set to [ON].

## • Setting procedure

- Press the item UP switch to select the item which is the next one up from the current item on the menu.
- Press the item DOWN switch to select the item which is the next one down from the current item on the menu.
- When the DATA YES/UP switch is pressed while the main menu is displayed, the submenus of the items are displayed. When it is pressed while a submenu is displayed, the setting is incremented.
- When the DATA NO/DOWN switch is pressed while the main menu is displayed, the item which is the next one down from the current item on the menu. When it is pressed while a submenu is displayed, the setting is decremented.
- After setting or changing the menu items, set the menu ON/OFF switch to [OFF].  
From this point on, the camera will operate under these settings.

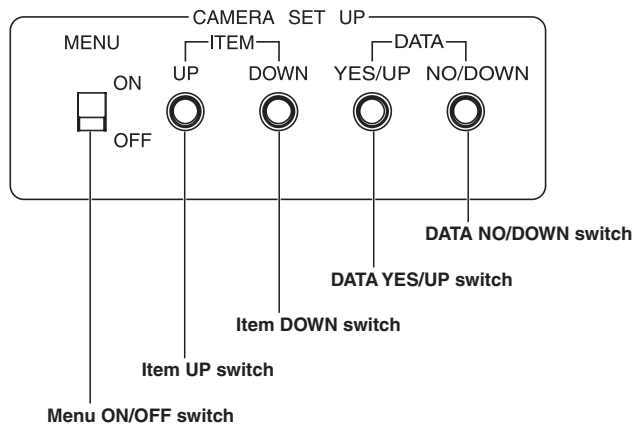

# Rack mounting

When the unit is to be mounted on a EIA 19-inch rack, use rack mount angles (provided) and four mounting screws (M4×10) (provided).

1. Turn off the power switch of the unit.
2. Remove four screws fixing the rubber feet and remove the four rubber feet from the bottom of the unit.

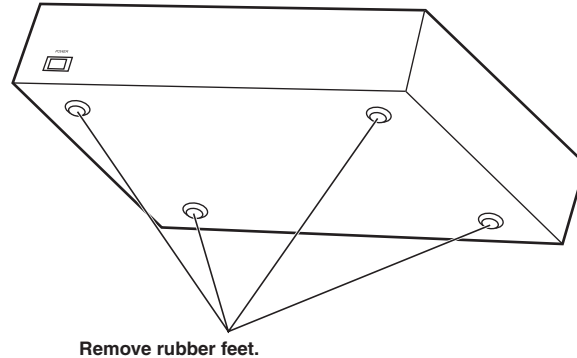

3. Fix the rack angle handle by using four rack angle handle fixing screws.
4. Attach the rack mount angles on both sides and fix them by using four mounting screws provided with the rack mount angle.

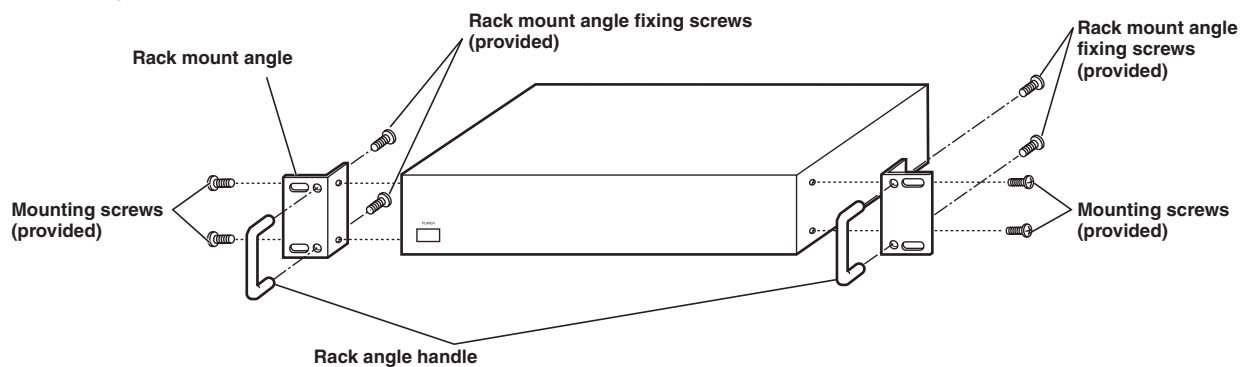

5. Install the unit on the EIA 19-inch rack by using four screws (locally purchased).

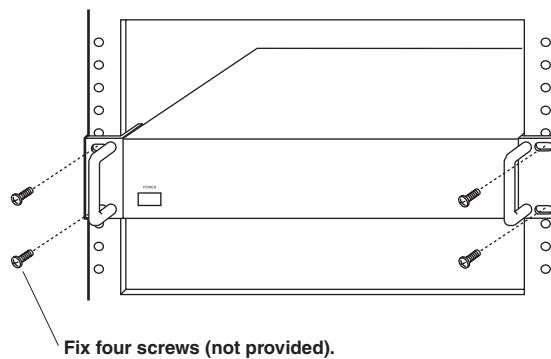

## Cautions:

- Do not use the unit on the place affected by the vibration.
- When the fan is used to keep the temperature in the rack within 122°F (+50°C), it should be put apart from the monitor.



# Specifications

---

<b>Power supply:</b> 120V AC, 60 Hz
<b>Power consumption:</b> Approx. 67 W

 indicates safety information.

<b>Video output:</b>	Composite signal 1.0 Vp-p/75Ω×2 (BNC connector) R/G/B, Y/PR/PB, Y/C signal (switch)×1 each (BNC connector) R, B: 0.7 Vp-p/75Ω, G: 1.0 Vp-p/75Ω (with SYNC) Y: 1.0 Vp-p/75Ω, PR, PB: 0.7 Vp-p/75Ω Y: 1.0 Vp-p/75Ω, C: 0.286 Vp-p/75Ω SYNC signal (Negative polarity) 2 Vp-p/75Ω×1 (BNC connector) S-Video signal Y: 1.0 Vp-p/75Ω, C: 0.286 Vp-p/75Ω (S-Video connector) • The above values are the values which are cable-compensated by this unit after they have been output from the camera at a regular level.
<b>Genlock input:</b>	1.0 Vp-p composite video signal or black burst signal/75Ω or High impedance (automatic terminated BNC connector)
<b>AUX input:</b>	1.0 Vp-p composite video signal/75Ω or High impedance (automatic terminated BNC connector)
<b>Pan/tilt head control input:</b>	Pan/tilt head (up, down, right, left, defroster, wiper), lens (zoom, focus) D-SUB 15-pin (female)
<b>Switch function:</b>	Gain up selection, AGC selection, color bar/camera selection, detail compensation selection, auto white/auto black set, white balance selection, scene file, electronic shutter switch, lens iris selection, subcarrier phase coarse adjustment, cable compensator selection, user set, menu, item up, item down
<b>Adjustment function:</b>	R•B gain, R•B pedestal, total pedestal, lens iris adjustment, INCOM level, horizontal phase, subcarrier phase finely adjustment, Y gain adjustment, chroma gain adjustment
<b>TALLY/INCOM connector:</b>	D-SUB 15-pin (female)
<b>INCOM connector:</b>	XLR 4-pin (male)
<b>Maximum cable length:</b>	984 ft. (300 m) (convertible camera unit) 328 ft. (100 m) (AW-E860 + AW-PB305 + Viewfinder)
<b>Operating temperature:</b>	14°F to 113°F (−10°C to +45°C)
<b>Dimensions (W×H×D):</b>	16-9/16"×3-7/16"×9-13/16" (420×88×250 mm) (excluding protrusions)
<b>Weight:</b>	Approx. 12.3 lbs. (5.6 kg)
<b>Finish:</b>	AV ivory paint (color resembling Munsell 7.9Y 6.8/0.8)

Weight and dimensions shown are approximate.  
Specifications are subject to change without notice.



# Panasonic<sup>®</sup>

**PANASONIC BROADCAST & TELEVISION SYSTEMS COMPANY**  
UNIT COMPANY OF PANASONIC CORPORATION OF NORTH AMERICA

**Executive Office:**

One Panasonic Way 4E-7, Secaucus, NJ 07094 (201) 348-7000

**EASTERN ZONE:**

One Panasonic Way 4E-7, Secaucus, NJ 07094 (201) 348-7621

**Southeast Region:**

1225 Northbrook Parkway, Ste 1-160, Suwanee, GA 30024 (770) 338-6835

**Central Region:**

1707 N Randall Road E1-C-1, Elgin, IL 60123 (847) 468-5200

**WESTERN ZONE:**

3330 Cahuenga Blvd W., Los Angeles, CA 90068 (323) 436-3500

**Government Marketing Department:**

52 West Gude Drive, Rockville, MD 20850 (301) 738-3840

**Broadcast PARTS INFORMATION & ORDERING:**

9:00 a.m. – 5:00 p.m. (PST) (800) 334-4881/24 Hr. Fax (800) 334-4880

Emergency after hour parts orders (800) 334-4881

**TECHNICAL SUPPORT:**

Emergency 24 Hour Service (800) 222-0741

**Panasonic Canada Inc.**

5770 Ambler Drive, Mississauga, Ontario L4W 2T3 (905) 624-5010

**Panasonic de Mexico S.A. de C.V.**

Av angel Urzaa Num. 1209 Col. de Valle 03100 Mexico, D.F. (52) 1 951 2127

**Panasonic Puerto Rico Inc.**

San Gabriel Industrial Park, 65th Infantry Ave., Km. 9.5, Carolina, Puerto Rico 00630 (787) 750-4300

© 2006 Matsushita Electric Industrial Co., Ltd. All rights reserved.